



DE | EN
2016 | 10

Aufbaukomponenten und Zubehör Seitengardine

Structural components and accessories for side curtain



Inhaltsangabe · *Table of contents*

| | |
|--|---|
| Übersicht Aufbaukomponenten / Zubehör Seitengardine <i>Overall view structural components / accessories for side curtain</i> | 3 |
|--|---|

Aufbaukomponenten / Zubehör Seitengardine ***Structural components / accessories for side curtain***

| | |
|---|----|
| Komponenten Front · <i>Components front</i> | 4 |
| Komponenten Mitte · <i>Components centre</i> | 5 |
| Komponenten Heck · <i>Components rear</i> | 6 |
| Komponenten Zubehör · <i>Components accessories</i> | 7 |
| CurtainSider · <i>CurtainSider</i> | 8 |
| Vollplane · <i>Full tarpaulin</i> | 10 |

Übersicht Aufbaukomponenten / Zubehör Seitengardine

Overall view structural components / accessories for side curtain

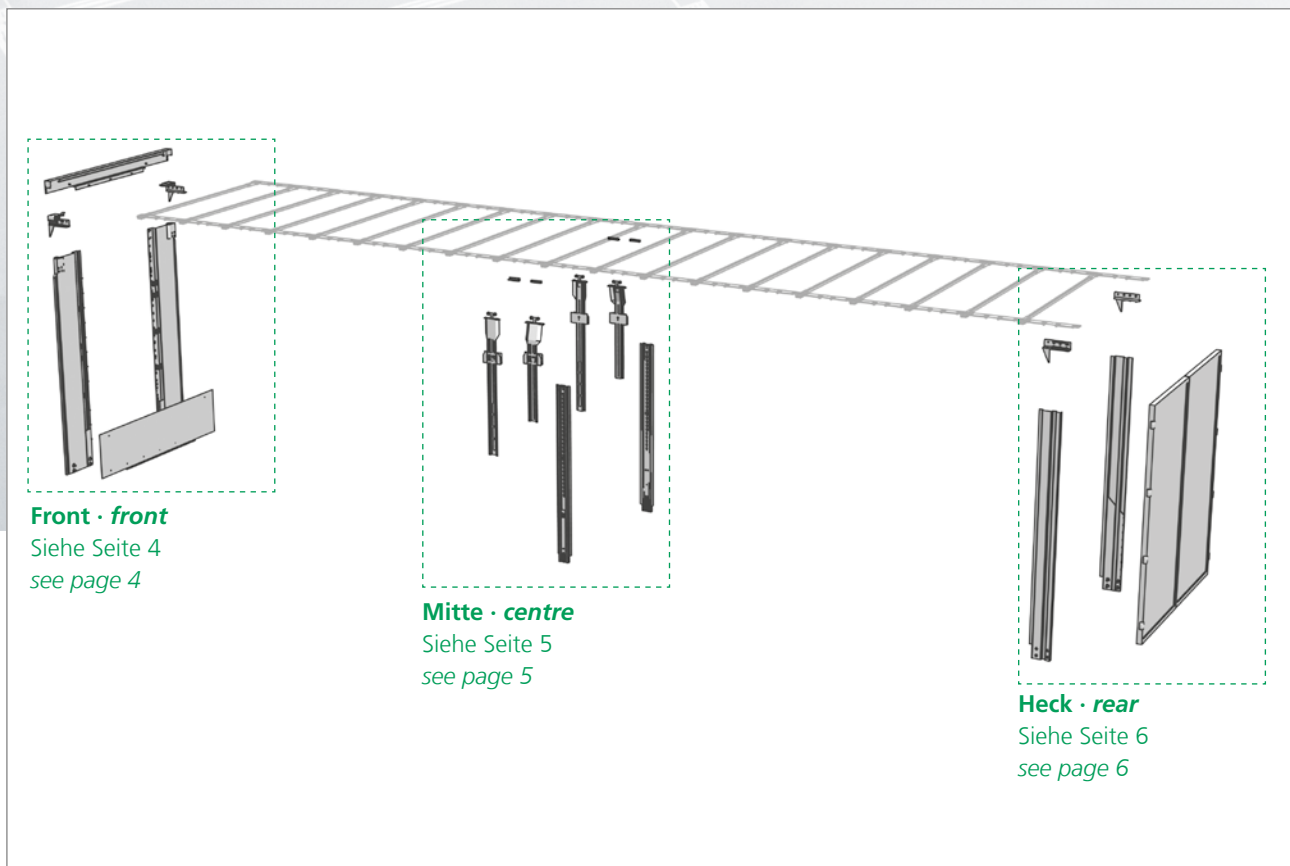

beinhaltet folgende Einzelkomponenten (in unterschiedlichen Stückzahlen):
Includes the following individual components (in different quantities):

Stirnwand 2021 · *Front frame 2021*

Montagesätze · *Assembly sets*

Schieberungen LP-2 · *Sliding pillars LP-2*

Heckrahmen 2102 · *Rear frame 2102*

Türen · *Doors*

Aluminium Spannrohre · *Aluminium draw-in tubes*

Spannratschen · *Tensioning ratchets*

Spannrohradapter · *Draw-in tube adapter*

Aufbaukomponenten / Zubehör Seitengardine Structural components / accessories for side curtain

Komponenten Front · Components front

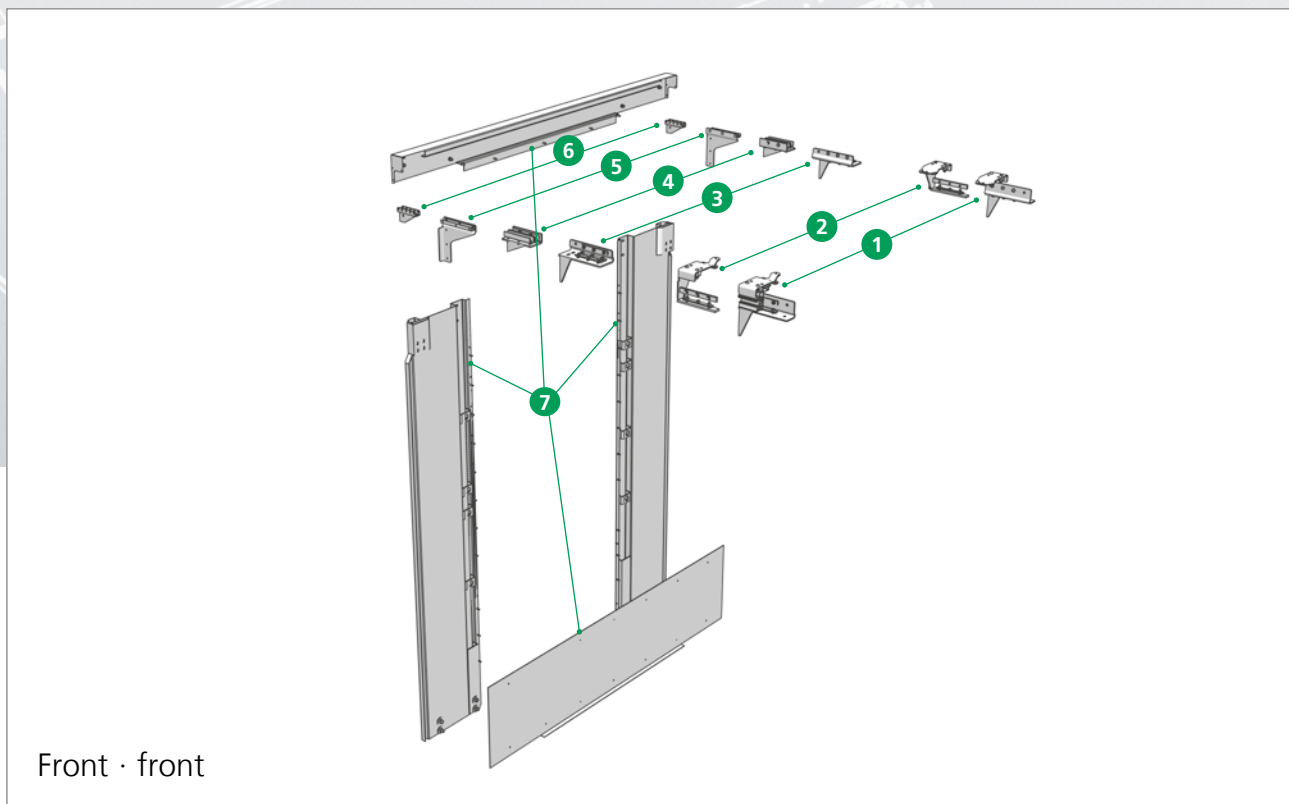

| Pos. | Best.-Nr. Order-No. | Bezeichnung · Designation |
|--|------------------------|--|
| Zubehör für Fahrzeugstatik, Zusatzausstattung Accessories for vehicle statics, additional equipment | | |
| 1 | 69 000 090 | Montagesatz CS Standard Front · Assembly kit CS standard front |
| 2 | 69 000 070 | Montagesatz CS Volumen Front · Assembly kit CS volume front |
| 3 | 38 077 820 | Montagesatz CS Universal Front · Assembly kit CS universal front |
| 4 | 38 029 750 | Montagesatz CS Universal Classic Front · Assembly kit CS universal classic front |
| 5 | 38 035 040 | Montagesatz Eckrunge · Mounting kit corner pillar |
| 6 | 38 084 460 | Montagesatz VP Stahl Front · Assembly kit VP steel front |
| 7 | 38 082 600 | Stirnwand 2021 · Front frame 2021 |

Komponenten Mitte · *Components centre*

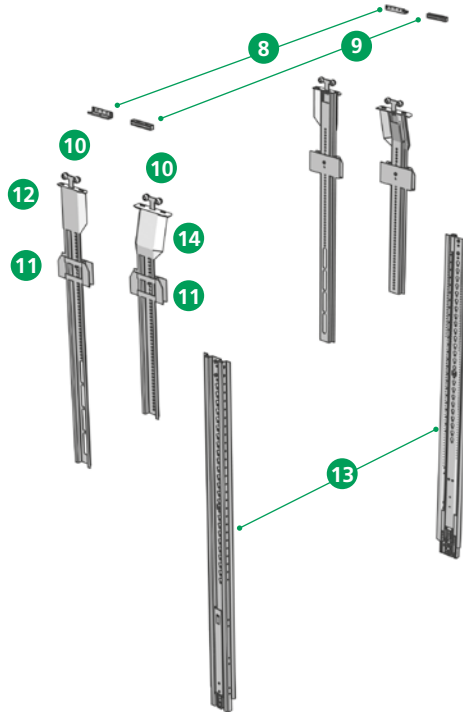

Mitte · centre

| Pos. | Best.-Nr. Order-No. | Bezeichnung · Designation |
|--|------------------------|---|
| Zubehör für Fahrzeugstatik, Zusatzausstattung Accessories for vehicle statics, additional equipment | | |
| 8 | 38 030 700 | Stützenanschluss Mitte VP Stahl · <i>Support connection VP centre steel</i> |
| 9 | 38 030 720 | Verbindungsbolzen mit Gewinde M 10 VP Stahl <i>Connection bolt with thread M 10 VP steel</i> |
| 10 | 90 000 571 | Roller LP-2 50/40 · <i>Roller LP-2 50/40</i> |
| 11 | 28 010 602 | Einsteckt.-Befestigungspl. Kopfstück <i>Insert pocket mounting plate for head end</i> |
| 12 | 28 010 232 | Kopfstück LP-2 1700/0 · <i>Head end LP-2 1700/0</i> |
| 13 | 28 020 031 | Sicherheitsrunge LP-2 Standard <i>Safe pillar LP-2 standard</i> |
| 14 | 28 010 282 | Kopfstück LP-2 1200/45 · <i>Head end LP-2 1200/45</i> |

Aufbaukomponenten / Zubehör Seitengardine Structural components / accessories for side curtain

Komponenten Heck · Components rear

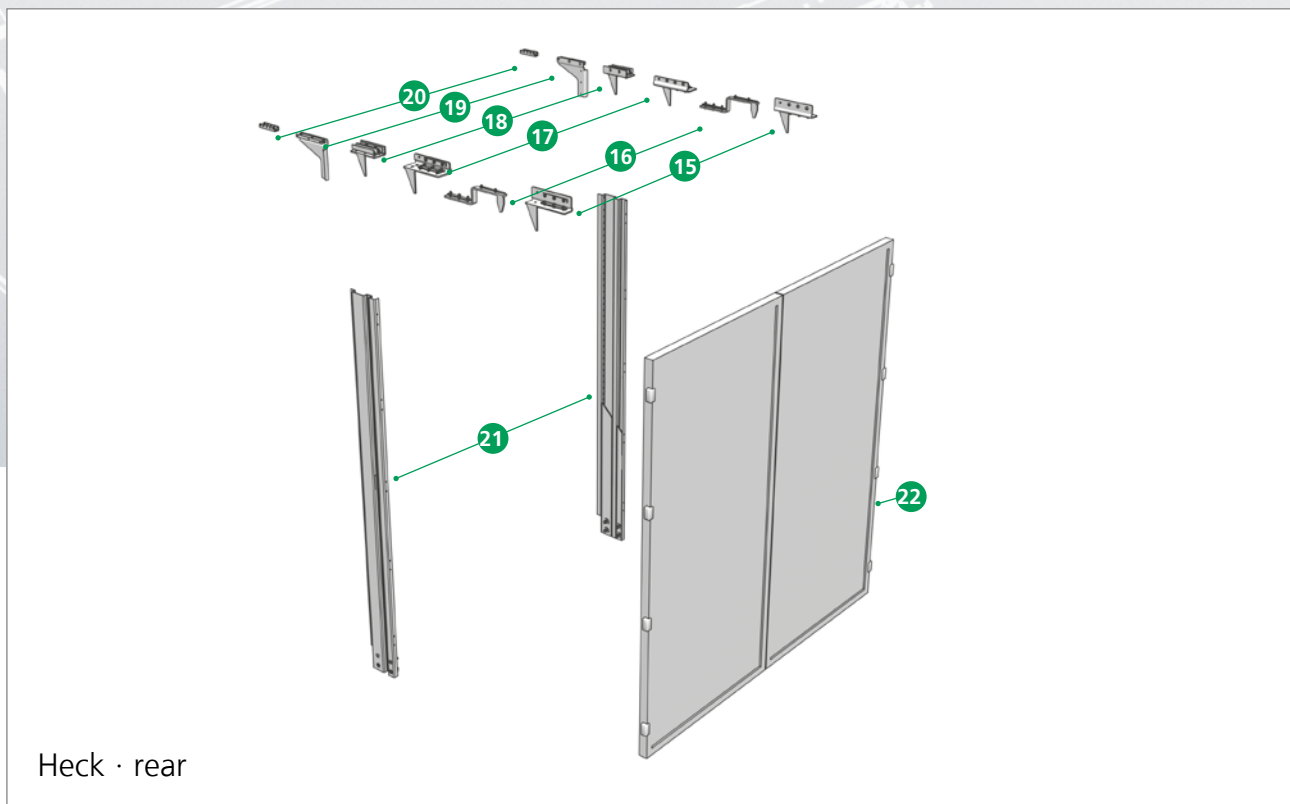

Heck · rear

| Pos. | Best.-Nr. Order-No. | Bezeichnung · Designation |
|--|------------------------|--|
| Zubehör für Fahrzeugstatik, Zusatzausstattung Accessories for vehicle statics, additional equipment | | |
| 15 | 69 000 100 | Montagesatz CS Standard Heck · Assembly kit CS standard rear |
| 16 | 69 000 080 | Montagesatz CS Volumen Heck · Assembly kit CS volume rear |
| 17 | 38 077 820 | Montagesatz CS Universal Heck · Assembly kit CS universal rear |
| 18 | 38 029 750 | Montagesatz CS Universal Classic Heck · Assembly kit CS universal classic rear |
| 19 | 38 035 040 | Montagesatz Eckrunge · Mounting kit corner pillar |
| 20 | 38 084 500 | Montagesatz VP Stahl Heck · Assembly kit VP steel rear |
| 21 | 38 084 470 | Heckrahmen 2102 · Rear frame 2102 |
| 22 | 38 084 480 | Türensatz 3 Scharniere · Door set 3 hinges |
| 23 | 38 084 490 | Türensatz 4 Scharniere · Door set 4 hinges |

Aufbaukomponenten / Zubehör Seitengardine Structural components / accessories for side curtain

Komponenten Zubehör · Components accessories

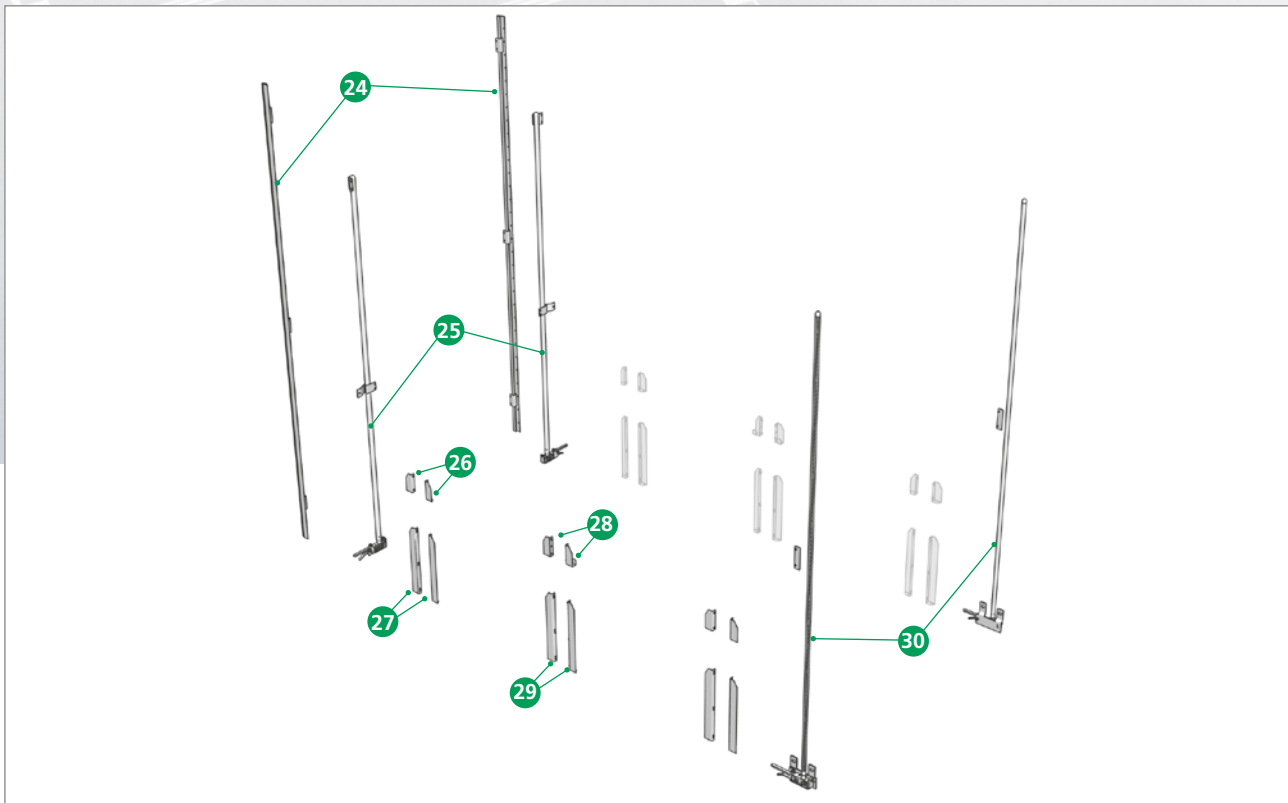

| | Order-No. | Designation |
|--------------------|------------|--|
| Accessories | | |
| 24 | 38 082 840 | Spannhakensatz Vorne 2021 · <i>Tensioning hook set front 2021</i> |
| 25 | 38 082 850 | Spannsatz mit Ratsche Vorne 2021 · <i>Tensioning set with ratchet front 2021</i> |
| 26 | 38 082 820 | Lattentaschen Kurz (2021-2102) Front · <i>Lath pockets short (2021-2102) front</i> |
| 27 | 38 082 830 | Lattentaschen lang (2021-2102) Front · <i>Lath pockets long (2021-2102) front</i> |
| 28 | 29 002 021 | Satz Lattentaschen kurz · <i>Set of lath pockets short</i> |
| 29 | 29 002 051 | Satz Lattentaschen lang · <i>Set of lath pockets long</i> |
| 30 | 38 083 750 | Spannsatz 2102 Rohr mit Ratsche · <i>Tensioning set 2102 tube with ratchet</i> |

CurtainSider

Profile
Profile

Montagesätze
Assembly kit

Profilabdichtungen
Profile seals

Rungenlaufwagen
Stanchion roller
carrier

Seitenplanenroller
Side tarpaulin
roller

Standard

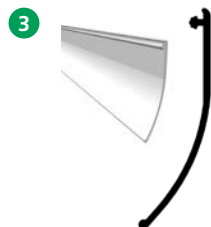
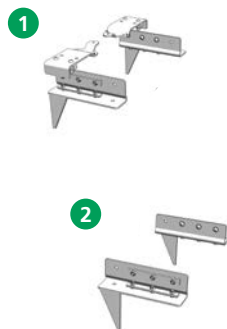
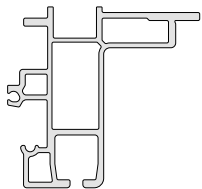

Volumen · Volume

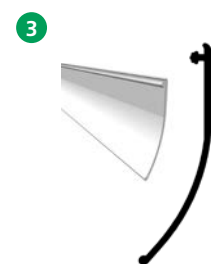
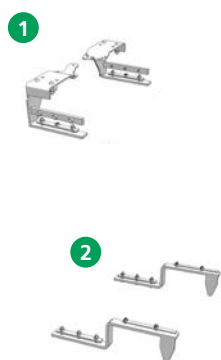
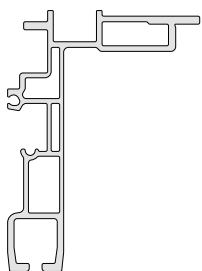

CurtainSider

Tabelle · Table

Standard

| Pos. | Best.-Nr. · Order-No. | Bezeichnung · Designation |
|------|-----------------------|--|
| 1 | 69 000 090 | Montagesatz Standard, vorne · <i>Assembly kit standard, front</i> |
| 2 | 69 000 100 | Montagesatz Standard, hinten · <i>Assembly kit standard, rear</i> |
| 3.1 | 38 059 970 | Profilabdichtung 13700 x 130 schwarz Standard/Universal (Rolle) <i>PVC pelmet 13700 x 130 black Standard/Universal(roll)</i> |
| 3.2 | 38 059 980 | Profilabdichtung 18500 x 130 schwarz Standard/Universal (Rolle) <i>PVC pelmet 18500 x 130 black Standard/Universal (roll)</i> |
| 4 | 38 048 420 | Rungenlaufwagen CS 125 / CS 175 · <i>Stanchion roller carrier CS 125 / CS 175</i> |
| 5.1 | 38 085 800 | Seitenplanenroller - Kunststoff mit Clip · <i>Tarpaulin Roller with Clip</i> |
| 5.2 | 38 085 810 | Seitenplanenroller - Kunststoff ohne Clip · <i>Tarpaulin Roller ohne Clip</i> |
| 6 | 38 088 940 | Seitenplanenroller SPR-4 · <i>Side tarpaulin roller SPR-4</i> |

Volumen · Volume

| Pos. | Best.-Nr. · Order-No. | Bezeichnung · Designation |
|------|-----------------------|--|
| 1 | 69 000 070 | Montagesatz Volumen, vorne · <i>Assembly kit volume, front</i> |
| 2 | 69 000 080 | Montagesatz Volumen, hinten · <i>Assembly kit volume, rear</i> |
| 3.1 | 38 061 460 | Profilabdichtung 13700 x 115 grau seitliche Aufnahme/Volumen (Rolle) <i>PVC pelmet 13700 x 115 grey side connection/Volume (roll)</i> |
| 3.2 | 38 061 470 | Profilabdichtung 18500 x 115 grau seitliche Aufnahme/Volumen (Rolle) <i>PVC pelmet 18500 x 115 grey side connection/Volume (roll)</i> |
| 3.3 | 38 061 480 | Profilabdichtung 13700 x 115 schwarz seitliche Aufnahme/Volumen (Rolle) <i>PVC pelmet 13700 x 115 black side connection/Volume (roll)</i> |
| 3.4 | 38 061 490 | Profilabdichtung 18500 x 115 schwarz seitliche Aufnahme/Volumen (Rolle) <i>PVC pelmet 18500 x 115 black side connection/Volume (roll)</i> |
| 4 | 38 048 420 | Rungenlaufwagen CS 125 / CS 175 · <i>Stanchion roller carrier CS 125 / CS 175</i> |
| 5.1 | 38 085 800 | Seitenplanenroller - Kunststoff mit Clip · <i>Tarpaulin Roller with Clip</i> |
| 5.2 | 38 085 810 | Seitenplanenroller - Kunststoff ohne Clip · <i>Tarpaulin Roller ohne Clip</i> |
| 6 | 38 088 940 | Seitenplanenroller SPR-4 · <i>Side tarpaulin roller SPR-4</i> |

CurtainSider

Profile
Profile

Montagesätze
Assembly kit

Profilabdichtungen
Profile seals

Rungenlaufwagen
Stanchion roller
carrier

Seitenplanenroller
Side tarpaulin
roller

Universal

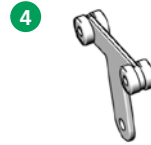
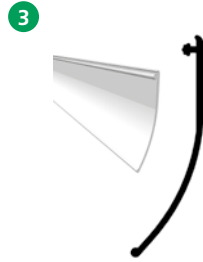
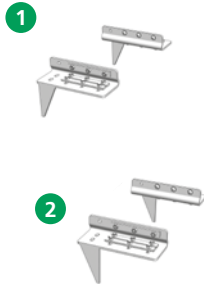
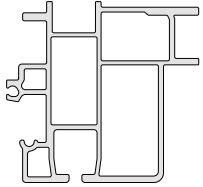

Universal Classic

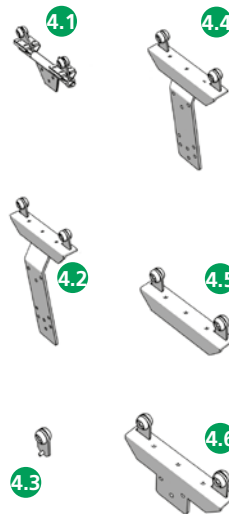
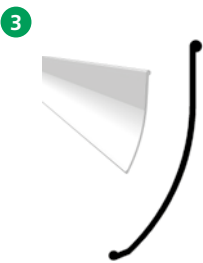
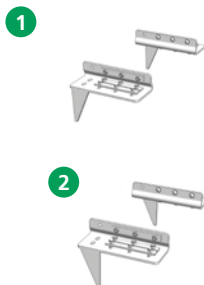
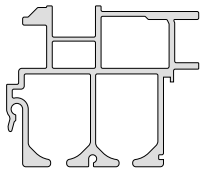

CurtainSider

Tabelle · Table

Universal

| Pos. | Best.-Nr. · Order-No. | Bezeichnung · Designation |
|------|-----------------------|--|
| 1 | 38 077 820 | Montagesatz Universal, vorne · <i>Assembly kit universal, front</i> |
| 2 | 38 077 820 | Montagesatz Universal, hinten · <i>Assembly kit universal, rear</i> |
| 3.1 | 38 059 950 | Profilabdichtung 13700 x 130 grau Standard/Universal (Rolle) <i>PVC pelmet 13700 x 130 grey Standard/Universal (roll)</i> |
| 3.2 | 38 059 960 | Profilabdichtung 18500 x 130 grau Standard/Universal (Rolle) <i>PVC pelmet 18500 x 130 grey Standard/Universal (roll)</i> |
| 3.3 | 38 059 970 | Profilabdichtung 13700 x 130 schwarz Standard/Universal (Rolle) <i>PVC pelmet 13700 x 130 black Standard/Universal (roll)</i> |
| 3.4 | 38 059 980 | Profilabdichtung 18500 x 130 schwarz Standard/Universal (Rolle) <i>PVC pelmet 18500 x 130 black Standard/Universal (roll)</i> |
| 4 | 38 048 420 | Rungenlaufwagen CS 125 / CS 175 · <i>Stanchion roller carrier CS 125 / CS 175</i> |
| 5.1 | 38 085 810 | Seitenplanenroller - Kunststoff mit Clip · <i>Tarpaulin Roller with Clip</i> |
| 5.2 | 38 085 810 | Seitenplanenroller - Kunststoff ohne Clip · <i>Tarpaulin Roller ohne Clip</i> |
| 6 | 38 088 940 | Seitenplanenroller SPR-4 · <i>Side tarpaulin roller SPR-4</i> |

Universal Classic

| Pos. | Best.-Nr. · Order-No. | Bezeichnung · Designation |
|------|-----------------------|--|
| 1 | 38 029 750 | Montagesatz Universal Classic, vorne · <i>Assembly kit universal classic, front</i> |
| 2 | 38 029 750 | Montagesatz Universal Classic, hinten · <i>Assembly kit universal classic, rear</i> |
| 3.1 | 01 007 584 | Profilabdichtung 33000 x 120 grau Universal Classic (Rolle) <i>PVC pelmet 33000 x 120 grey Universal Classic (roll)</i> |
| 3.2 | 01 007 585 | Profilabdichtung 33000 x 120 grau Universal Classic (Rolle) <i>PVC pelmet 33000 x 120 grey Universal Classic (roll)</i> |
| 3.3 | 01 008 282 | Profilabdichtung 14000 x 120 grau Universal Classic (Rolle) <i>PVC pelmet 14000 x 120 grey Universal Classic (roll)</i> |
| 3.4 | 01 007 584 | Profilabdichtung 14000 x 120 schwarz Universal Classic (Rolle) <i>PVC pelmet 14000 x 120 black Universal Classic (roll)</i> |
| 4.1 | 38 025 390 | Rungenlaufwagen drehbar · <i>Stanchion roller carriage rotatable</i> |
| 4.2 | 38 032 400 | Rungenlaufwagen (nur für Planenroller 40 38 031 360 geeignet) <i>Stanchion roller carrier (to be used with curtain roller 40 38 031 360 only)</i> |
| 4.3 | 38 030 450 | Laufrolle mit Lasche · <i>Roller with flap</i> |
| 4.4 | 38 031 490 | Rungenlaufwagen · <i>Stanchion roller carrier</i> |
| 4.5 | 38 032 100 | Rungenlaufwagen · <i>Stanchion roller carrier</i> |
| 4.6 | 38 031 950 | Rungenlaufwagen · <i>Stanchion roller carrier</i> |
| 5.1 | 38 031 360 | Seitenplanenroller · <i>Side tarpaulin roller</i> |
| 5.2 | 00 083 006 | Seitenplanenroller · <i>Side tarpaulin roller</i> |
| 5.3 | 00 032 336 | Gurtrolle · <i>Belt roller</i> |

Vollplane · Full Tarpaulin

Profile
Profile

Montagesätze
Assembly kit

Profilabdichtungen
Profile seals

Rungenlaufwagen
Stanchion roller
carrier

Seitenplanenroller
Side tarpaulin
roller

Stahlträger · Steel beam

74 611

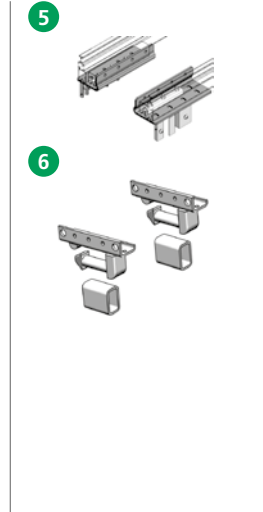
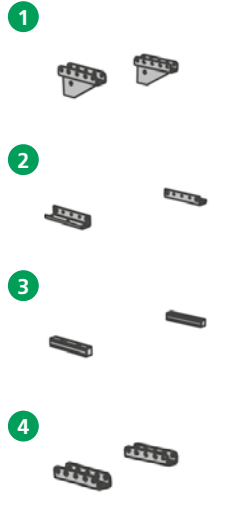
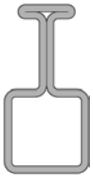

Aluträger Compact · Aluminum beam Compact

900 407

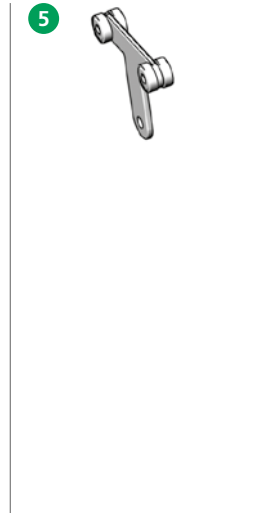
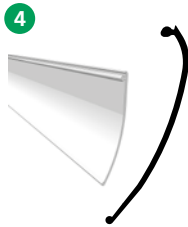
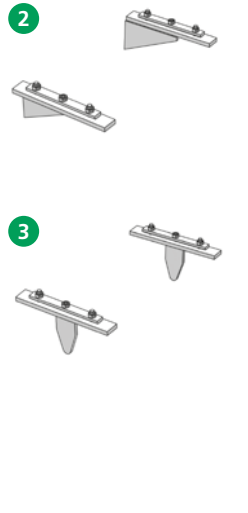
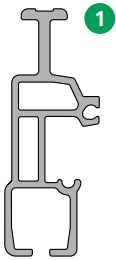

Vollplane · Full Tarpaulin

Tabelle · Table

Stahlträger · Steel beam

74 611

| Pos. | Best.-Nr. · Order-No. | Bezeichnung · Designation |
|------|-----------------------|---|
| 1 | 38 084 460 | Montagesatz VP Stahl Front · <i>Assembly kit VP steel front</i> |
| 2 | 38 030 700 | Stützenanschluss Mitte VP Stahl · <i>Support connection VP centre steel</i> |
| 3 | 38 030 720 | Verbindungsbolzen mit Gewinde M 10 VP Stahl <i>Connection bolt with thread M 10 VP Steel</i> |
| 4 | 38 032 360 | Stützenanschluss mit Bolzen <i>Support connection with bolt</i> |
| 5 | 38 084 500 | Montagesatz VP Stahl Heck · <i>Assembly kit VP steel rear</i> |
| 6 | 38 068 700 | Stützenanschluss (Topkupplung) Satz · <i>Pillar connection (top coupling) set</i> |

Aluträger Compact · Aluminum beam Compact

900 407

| Pos. | Best.-Nr. · Order-No. | Bezeichnung · Designation |
|------|-----------------------|--|
| 2 | 69 004 920 | Aluträger Compact (L = 8 m) · <i>Aluminium beam Compact (L = 8 m)</i> |
| 2 | 69 006 040 | Aluträger Compact (L = 5 m) · <i>Aluminium beam Compact (L = 5 m)</i> |
| 2 | 69 000 130 | Montagesatz Compact Profil vorne · <i>Assembly kit Compact profile front</i> |
| 3 | 69 000 140 | Montagesatz Compact Profil hinten · <i>Assembly kit Compact profile rear</i> |
| 4.1 | 38 087 380 | Profilabdichtung 13700 x 125 grau Standard/Universal (Rolle) <i>PVC pelmet 13700 x 125 grey Standard/Universal (roll)</i> |
| 4.1 | 38 087 390 | Profilabdichtung 18500 x 125 grau Standard/Universal (Rolle) <i>PVC pelmet 18500 x 125 grey Standard/Universal (roll)</i> |
| 4.3 | 38 087 400 | Profilabdichtung 13700 x 125 schwarz Standard/Universal (Rolle) <i>PVC pelmet 13700 x 125 black Standard/Universal (roll)</i> |
| 4.4 | 38 087 410 | Profilabdichtung 18500 x 125 schwarz Standard/Universal (Rolle) <i>PVC pelmet 18500 x 125 black Standard/Universal (roll)</i> |
| 5 | 38 048 420 | Rungenlaufwagen CS 125 / CS 175 · <i>Stanchion roller carrier CS 125 / CS 175</i> |
| 6.1 | 38 085 800 | Seitenplanenroller - Kunststoff mit Clip · <i>Tarpaulin Roller with Clip</i> |
| 6.2 | 38 085 810 | Seitenplanenroller - Kunststoff ohne Clip · <i>Tarpaulin Roller ohne Clip</i> |
| 7 | 38 088 940 | Seitenplanenroller SPR-4 · <i>Side tarpaulin roller SPR-4</i> |

Skizzen · *Scetches*

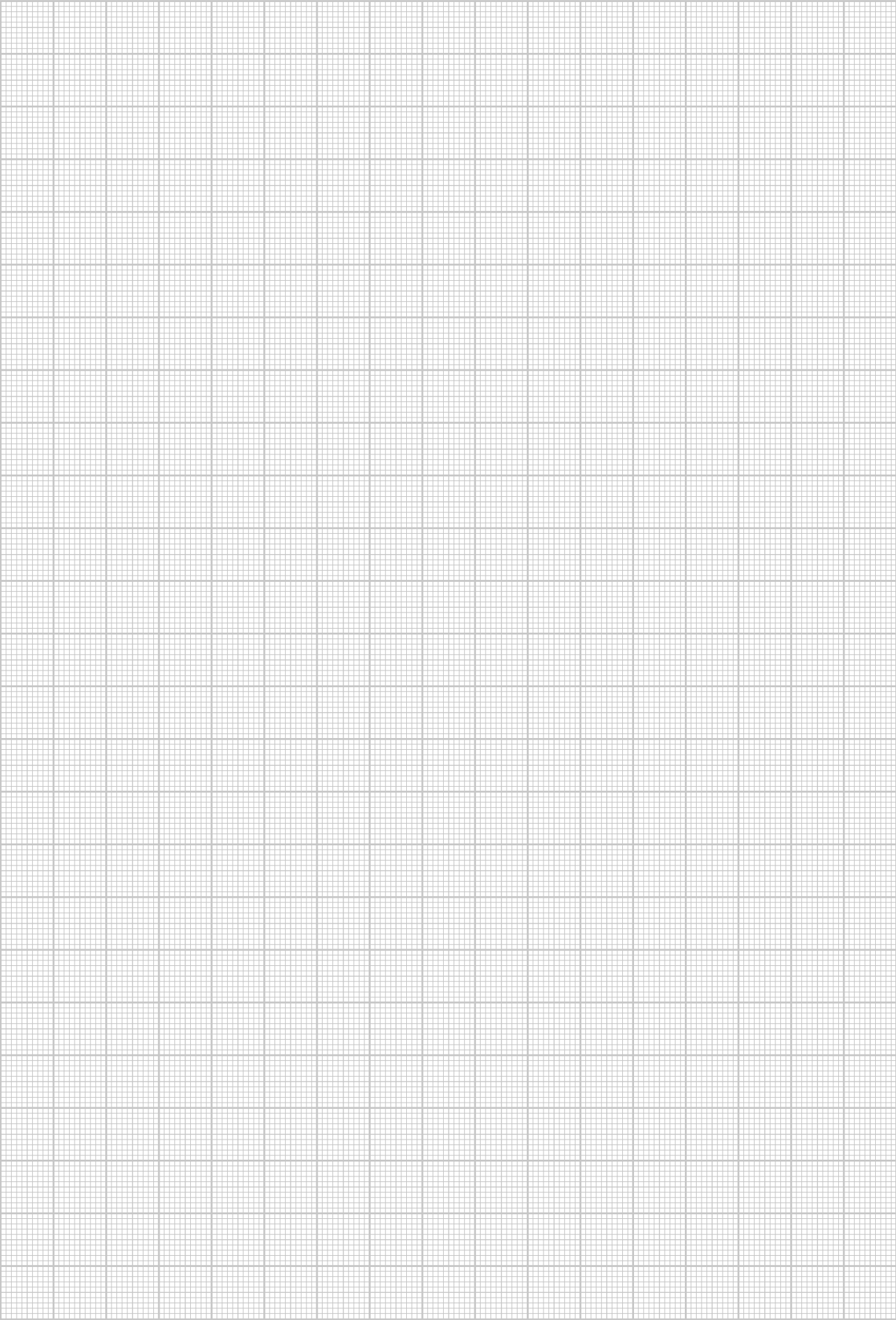



Alle technischen Änderungen vorbehalten · 10 / 2016

European Trailer Systems GmbH

Im Moerser Feld 1f, 47441 Moers, Germany

Phone: +49 (0) 2841 6070 700 · E-mail: marketing@EdschaTS.com

www.EdschaTS.com

Member of VBG Group



Das Original